

OUR SERVICES

Individual illumination jobs and sensor solutions

Micro workspaces
Image processing systems

Development and manufacture of customer specific component assemblies

Micro-optics > optical calculations > energy & irradiation paths
Mechanics > mechanical prototypes > null series > series
Electronics > circuit board layout and assembly > software

Fibre optic assemblies in special areas

Environmental conditions
Temperature, humidity, chemical influences liquids, gases, electrical shock, EMC

Optical guides for laser beam processing

Digitised, controllable light sources
Components for analysis technology
Optoelectronic assemblies for computer peripheries
Conversion of electrical, optical and mechanical characteristic curves into optical signals.

Areas of application

Microscopes and micro workplace illumination, image processing illumination, visual inspection, inspection tasks. Automation for manufacturing systems, filling stations, assembly lines, tool machines, packaging machines, printing machines...



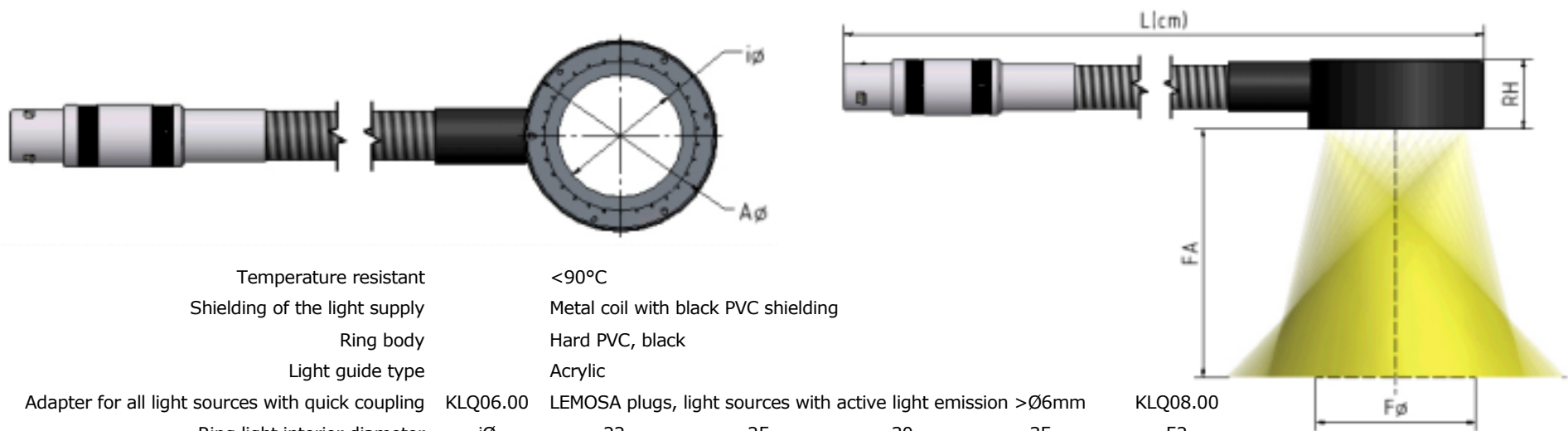

Temperature resistant		<90°C				
Shielding of the light supply		Metal coil with black PVC shielding				
Ring body		Hard PVC, black				
Light guide type		Acrylic				
Adapter for all light sources with quick coupling	KLQ06.00	LEMOSA plugs, light sources with active light emission >Ø6mm				KLQ08.00
Ring light interior diameter	iØ	22	25	30	35	52
Ring light exterior diameter	AØ	50	85/65	64	64	78
Ring light height	RH	23	18	22	22	23
Focal distance, working distance	FA	20	10-35	80	80	20-120
Light spot diameter	FØ	25	25	50	50	25
Number of light spots, resolution	PR	12	12	40	30	18
Light emission	PØ	1.5	1.5	1.5	1.5	1.5

DIFFUSED RING LIGHT HOMOGENEOUS

		RG22D	RG25D	RG30D	RG35D	RG52D
Light guide length, supply in cm	0060			214340 0°		
	0060			214877 12°		
	0100					204845 70°
	0100	101898	102730			101899
	0200				224013	204749
	0250					
www.FASEROPTIK-HENNING.de	0300				221034	222101
	0500					226848

Accessories Page 23

Reducing ring to adjust to the diameters of microscopes, cameras...

0° 12° 70° angle of the light spot axis to the ring light axis

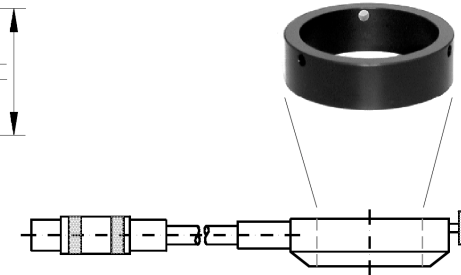
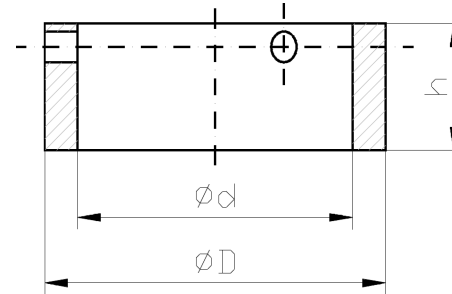
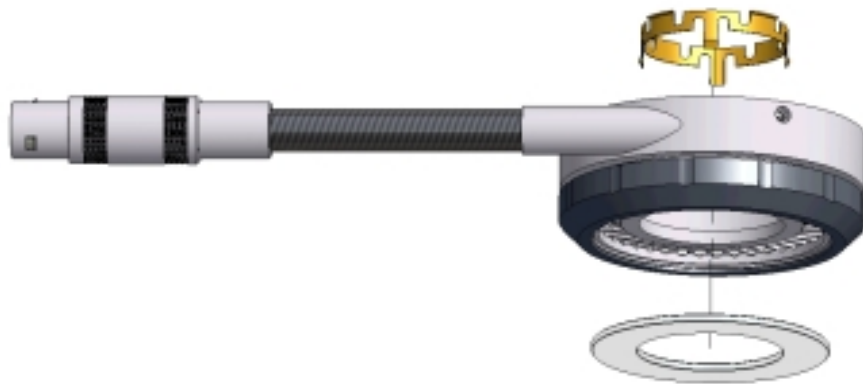

PROTECTIVE GLASS FOR RG52VF

Item Nr.	Description	Notes
227754	Protective glass disc	for RG52VF / iØ38mm / AØ61.8mm / thickness 2mm
227753	Snap ring	for protective glass disc RG52VF

Easy to exchange protective glass sheet

REDUCING RING FOR RG52X - RG66X

Item Nr.	ØD	ød	h
206475	52	37	11
206880	52	37.7	11
215088	52	40	19
208062	52	42	11
210185	52	46	11
102666	52	47	11
102652	52	48	11
102664	52	49	11
208662	66	52	19
209810	66	54	19
209621	66	60	19

Temperature resistance: <90°C

Ring body: Black plastic

Adjustment to the diameters of microscopes, cameras...

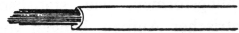

Light supply line sheath depending on application

MP- protective hose

MP



Material	Aluminium with plastic covering
temperature	-20°C to +80°C
Colours	black
Properties	very flexible, high tensile with high peak compressive strength

Flat cable coil - silicone protective hose

MS



Material	Protective hose stainless steel with silicone rubber sheath
temperature	-60°C to +180°C
Colours	grey
Properties	Silicone rubber sheath can be sterilised, is water-tight, and to a large extent resistant to chemicals and solvents, is stress-relieved and very flexible.

PVC hose

PC



Material	Polyvinylchloride (PVC)
temperature	up to approx. 70° C
Colours	black

Stainless steel protective hose

VA















Material	Stainless steel 1.4301
temperature	600°C
Colours	dark grey
Properties	Media resistance conforms to 1.4301 material

Alu- protective hose

AL



Material	Aluminium
temperature	-60°C to +180°C
Colours	silver
Properties	anti-kink protection

Decabon pipe		DK
	Material	Interior pipe made of double-sided coated overlapping aluminium foil, exterior sheath made of high density polyurethane (HD-PE)
	temperature	-25°C to +65°C
	Colours	black (standard)
	Properties	It can be easily formed by hand, retains its shape and does not spring back. It can be bent several times without damage.
PE protective hose		PE
 	Material	PE protective hose
	temperature	-0°C to +80°C
	Colours	black
	Properties	resistant to acids, alkalis and salt solutions / break and impact resistant
Tecalan protective hose		TC
	Material	Tecalan
	temperature	For continuous load -60°C to +100°C, for short-term loading to +130°C
	Colours	black
PU protective hose		PU
 	Material	Electrical discharge protective PU hose
	temperature	-40°C to +80°C
	Colours	black, blue, white
	Properties	High rupture stress, very good stability against cold, oils, fats, acids, alkalis and salt solutions; hardness: Shore A 98 Working pressure, temperature dependent! 12bar at 24°C 5bar at 66°C
PTFE coiled hose		PTFE
  	Material	PTFE coiled hose with glass fibre braiding
	temperature	-70°C to +260°C
	Colours	black
	Properties	non-flammable, chemical resistant
Silicone hose		SL
 	Material	Silicone hose
	temperature	-60°C to +200°C, short-term +260° C
	Colours	grey, black, transparent
	Properties	very flexible, acid and alkali resistant, Shore hardness A 55 ± 5°, autoclavable, ethylene oxide, light scent, non-toxic
PVC hose with fabric insert		GPVC
	Material	PVC hose with natural fabric insert
	temperature	-20°C to +65°C
	Colours	transparent
	Properties	permanently transparent, comfortable flexibility, good aging resistance, KTW approved, food materials approved according to RAL-E71

Fibre type	Acrylic fibre (Polymer Optical Fibre)	Glass fibre silicate glass fibre	Hardcoat fibre hard clad	Quartz fibre	Quartz fibre
Profile	Index step fibre (Si)	Index step fibre (Si)	Index step fibre (Si)	Index step fibre (Si)	Gradient fibre (Gi)
ØD Fibre exterior diameter	250µm 500µm 750µm 1000µm	30µm 50µm 70µm	125µm 225µm 425µm 630µm	155µm 250µm 270µm 415µm	125µm 140µm
Ød Fibre core diameter	240µm 490µm 740µm 990µm	27µm 47µm 67µm	100µm 200µm 400µm 600µm	105µm 200µm 200µm 320µm	85µm 100µm
NA Numerical Aperture	0.47	0.54	0.37	0.22	0.2
2α=ε Light exit angle	56°	65°	43°	25°	~25°
% Damping losses	200dB/km 3.4%/m at 580nm	200dB/km 4.5%/m at 820nm	10dB/km 0.002%/m (at 820 nm)	≥14db/km at 820nm	1dB/km at 13000nm
C° Temperature resistance	92	600	125	300	125

Light exit angle ϵ for various fibre materials

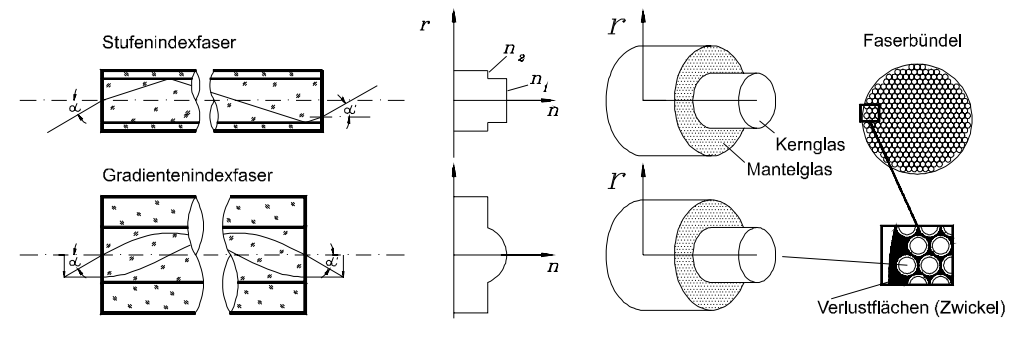
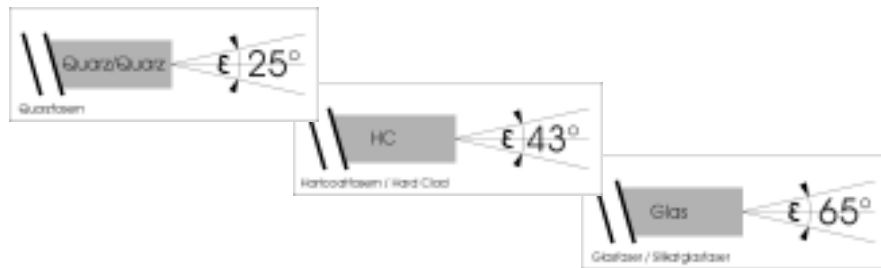

Faseroptik Henning GmbH

Neumarkter Straße 29

D 90584 Allersberg / Germany

Tel. 0049 (0)9176 / 58-0

Fax 0049 (0)9176 / 58-70

kontakt@faseroptik-henning.de

www.faseroptik-henning.de